

# MONTERINGSANVISNING    FITTING INSTRUCTIONS

## Ventilationbeslag Fix 92

För inåtgående fönster.

Barnskyddande, typgodkänd.

## Ventilation stay Fix 92

For inward-opening windows.

Childproof.

## Ingående artiklar / Parts included

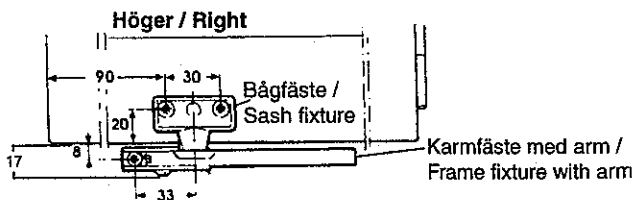
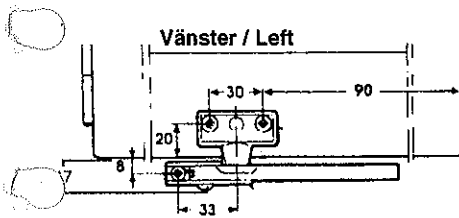
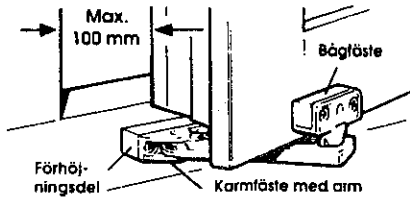
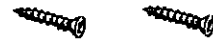
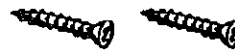
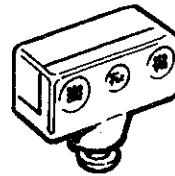

## Montering

Märk ut för bågfästet på bågen enl bild ovan.

Borra  $\varnothing$  2,5 mm till 15 mm djup. Skruva fast bågfästet.

Mät avståndet från karmen till bågens insida, mått T enligt bild. Välj en förhöjningsdel enligt tabell.

Märk ut för skruvarna på karmen i bild ovan.

Borra  $\varnothing$  2,0 mm till 20 mm djup. Skruva fast karmfästet med förhöjningsdelen på karmen enl bild ovan.

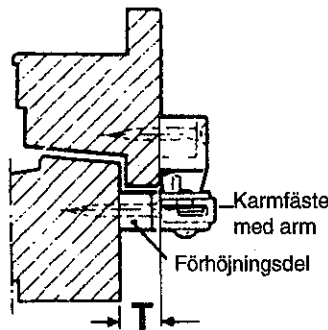

## Fitting

Mark the screw holes on the sash. Drill  $\varnothing$  2,5 mm to the depth of 15 mm.

Fit the sash fixture to the sash according to the figure above. Measure the distance from the sash to the inside of the frame, distance T according to the figure. Choose the distance piece according to the table.

Mark the screw holes on the frame according to the figure. Drill  $\varnothing$  2,0 mm to the depth of 20 mm. Fit the frame fixture with the distance piece on the frame.

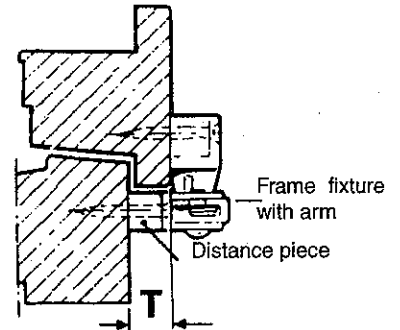

Koppling av spärrläget sker automatiskt när fönstret stängs.

## Större fönsteröppning än 100 mm:

T-mått mm	Förhöjningsdel
13-15	12
15-17	14
17-20	16

Förhöjningsdel no 2 med T-mått 3-5 mm kan fås mot beställning.

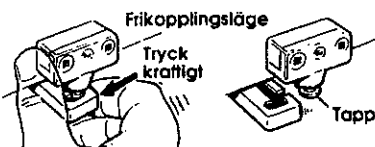

T mm	Distance-piece
13-15	12
15-17	14
17-20	16

Distancepiece no 2 with T 3-5 mm is possible to order when needed.

## Window opening larger than 100 mm:

